

# ***The Bose® Acoustimass® 15 Home Theater Speaker System***

*Owner's Guide*  
*October 22, 2001*



*AM194452\_06\_V.pdf*

### Thank you

We appreciate your choice of the Bose® Acoustimass® 15 home theater speaker system. With these Virtually Invisible® speakers you will surround yourself with realistic sound, with a minimal amount of equipment. Your system features new third generation Acoustimass cube speaker arrays, a product of the continuous research and development at Bose Corporation. These cube speakers deliver more lifelike sound and better overall performance, yet are smaller than their predecessors.

Your speaker system is completely compatible with the most modern home theater receivers and program material. Bose proprietary Integrated Signal Processing and dedicated bass amplification assure hi-fidelity and bass for all channels regardless of your home theater receiver's settings.

### Important Information

-  **WARNING:** To reduce the risk of fire or electric shock, do not expose the Powered Acoustimass module to rain or moisture.
-  **CAUTION:** To prevent electric shock, match wide blade of plug to wide slot, insert fully.

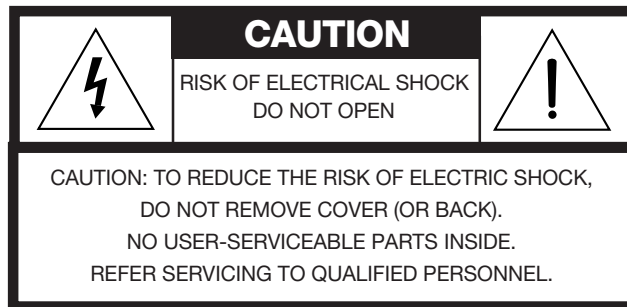

These CAUTION marks are located on the Acoustimass module:



The lightning flash with arrowhead symbol, within an equilateral triangle, is intended to alert the user to the presence of uninsulated dangerous voltage within the system enclosure that may be of sufficient magnitude to constitute a risk of electric shock.



The exclamation point within an equilateral triangle, as marked on the system, is intended to alert the user to the presence of important operating and maintenance instructions in this owner's guide.

### Additional safety information

See the additional instructions on the *Important Safety Information* page enclosed with this owner's guide.

### Please read this owner's guide

Please take the time to follow this owner's guide carefully. It will help you set up and operate your system properly, and enjoy all of its advanced features. Save your owner's guide for future reference.

## Important Safety Instructions

- 1. Read these instructions** – for all components before using this product.
- 2. Keep these instructions** – for future reference.
- 3. Heed all warnings** – on the product and in the owner's guide.
- 4. Follow all instructions.**
- 5. Do not use this apparatus near water or moisture** – Do not use this product near a bathtub, washbowl, kitchen sink, laundry tub, in a wet basement, near a swimming pool, or anywhere else that water or moisture are present.
- 6. Clean only with a dry cloth** – and as directed by Bose® Corporation. Unplug this product from the wall outlet before cleaning.
- 7. Do not block any ventilation openings. Install in accordance with the manufacturer's instructions** – To ensure reliable operation of the product and to protect it from overheating, put the product in a position and location that will not interfere with its proper ventilation. For example, do not place the product on a bed, sofa, or similar surface that may block the ventilation openings. Do not put it in a built-in system, such as a bookcase or a cabinet that may keep air from flowing through its ventilation openings.
- 8. Do not install near any heat sources, such as radiators, heat registers, stoves or other apparatus (including amplifiers) that produce heat.**
- 9. Do not defeat the safety purpose of the polarized or grounding-type plug. A polarized plug has two blades with one wider than the other. A grounding-type plug has two blades and a third grounding prong. The wider blade or third prong are provided for your safety. If the provided plug does not fit in your outlet, consult an electrician for replacement of the obsolete outlet.**
- 10. Protect the power cord from being walked on or pinched, particularly at plugs, convenience receptacles, and the point where they exit from the apparatus.**
- 11. Only use attachments/accessories specified by the manufacturer.**
- 12. Use only with the cart, stand, tripod, bracket or table specified by the manufacturer or sold with the apparatus. When a cart is used, use caution when moving the cart/apparatus combination to avoid injury from tip-over.**
- 13. Unplug this apparatus during lightning storms or when unused for long periods of time** – to prevent damage to this product.
- 14. Refer all servicing to qualified service personnel. Servicing is required when the apparatus has been damaged in any way: such as power-supply cord or plug is damaged; liquid has been spilled or objects have fallen into the apparatus; the apparatus has been exposed to rain or moisture, does not operate normally, or has been dropped** – Do not attempt to service this product yourself. Opening or removing covers may expose you to dangerous voltages or other hazards. Please call Bose to be referred to an authorized service center near you.
- 15. To prevent risk of fire or electric shock, avoid overloading wall outlets, extension cords, or integral convenience receptacles.**
- 16. Do not let objects or liquids enter the product** – as they may touch dangerous voltage points or short-out parts that could result in a fire or electric shock.
- 17. See product enclosure for safety related markings.**

## Information about products that generate electrical noise

If applicable, this equipment has been tested and found to comply with the limits for a Class B digital device, pursuant to Part 15 of the FCC rules. These limits are designed to provide reasonable protection against harmful interference in a residential installation. This equipment generates, uses, and can radiate radio frequency energy and, if not installed and used in accordance with the instructions, may cause harmful interference to radio communications. However, this is no guarantee that interference will not occur in a particular installation. If this equipment does cause harmful interference to radio or television reception, which can be determined by turning the equipment off and on, you are encouraged to try to correct the interference by one or more of the following measures:

- Reorient or relocate the receiving antenna.
- Increase the separation between the equipment and receiver.
- Connect the equipment to an outlet on a different circuit than the one to which the receiver is connected.
- Consult the dealer or an experienced radio/TV technician for help.

**Note:** *Unauthorized modification of the receiver or radio remote control could void the user's authority to operate this equipment.*

This product complies with the Canadian ICES-003 Class B specifications.



## Important Safety Instructions

- 18. Use proper power sources** – Plug the product into a proper power source, as described in the operating instructions or as marked on the product.
- 19. Avoid power lines** – Use extreme care when installing an outside antenna system to keep from touching power lines or circuits, as contact with them may be fatal. Do not install external antennas near overhead power lines or other electric light or power circuits, nor where an antenna can fall into such circuits or power lines.
- 20. Ground all outdoor antennas** – If an external antenna or cable system is connected to this product, be sure the antenna or cable system is grounded. This will provide some protection against voltage surges and built-up static charges. Section 810 of the National Electrical Code ANSI/NFPA No. 70 provides information with respect to proper grounding of the mast and supporting structure, grounding of the lead-in wire to an antenna discharge unit, size of grounding conductors, location of antenna-discharge unit, connection to grounding electrodes, and requirements for the ground electrode. Refer to the antenna grounding illustration on this page.

## Antenna grounding

Example of antenna grounding as per National Electrical Code, ANSI/NFPA 70.

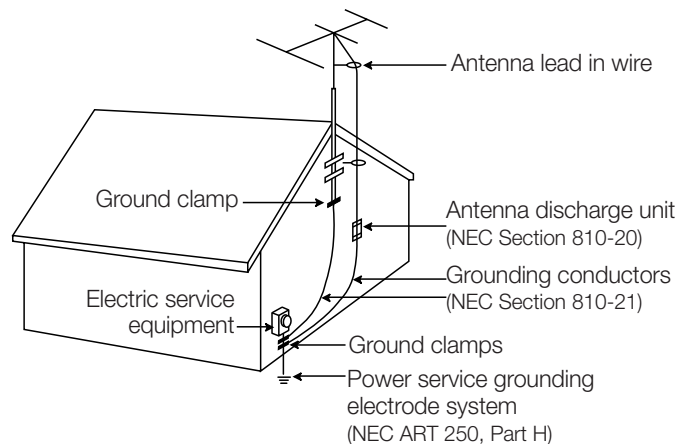

## Note to CATV system installer

This reminder is provided to call the CATV system installer's attention to Article 820-40 of the NEC (of USA) that provides guidelines for proper grounding. In particular, it specifies that the cable ground shall be connected to the grounding system of the building, as close to the point of cable entry as is practical.

**Where to find...**

Introduction  
 Thank you ..... 2  
 Important Information ..... 2  
 Contents  
 Where to find ..... 3  
 For your records ..... 3  
 Setting Up  
 Before you begin ..... 4  
 Unpack the carton ..... 4  
 Placing your speakers to achieve realistic home theater sound ..... 5  
     Center cube speaker ..... 5  
     Left and right front cube speakers ..... 6  
     Surround cube speakers ..... 6  
     Powered Acoustimass® module ..... 6  
 Connect the speakers ..... 7  
     Connect the Powered Acoustimass module to the center  
         and front cube arrays ..... 7  
     Connect the Powered Acoustimass module to the surround cube arrays ..... 8  
     Connect the Powered Acoustimass module to the receiver ..... 8  
 Check the connections ..... 9  
     Plug in the Powered Acoustimass Module ..... 9  
 Using Your Acoustimass 15 speakers  
     For realistic home theater sound ..... 10  
         LFE level control ..... 10  
         Bass control ..... 10  
         Setting your Dolby Pro-Logic receiver ..... 10  
         Setting your Dolby Digital receiver ..... 10  
         Be sure to get the Dolby Digital signal ..... 11  
 Maintaining Your Acoustimass 15 speakers  
     Troubleshooting ..... 12  
     Customer service ..... 12  
     Cleaning the speakers ..... 12  
 Product Information  
     Technical information ..... 13  
     Warranty period ..... 13  
     Accessories ..... 13  
 Bose® Corporation ..... inside back cover

**For your records**

Serial numbers are located on the connection panel of the Powered Acoustimass module.

Serial number: \_\_\_\_\_

Dealer name: \_\_\_\_\_

Dealer phone: \_\_\_\_\_ Purchase date: \_\_\_\_\_

We suggest you keep your sales slip and warranty card together with this owner's guide.

## Before you begin

Bose® Virtually Invisible® speaker technology allows you to enjoy lifelike home performances from the very latest surround-sound encoded movies, CDs, and television shows, without a room full of speakers. Each of the five cube speaker arrays, along with the Powered Acoustimass® module, reproduces the full-spectrum of sound from multi-channel digital programming. Integrated Signal Processing assures full bass performance from all channels, at all listening levels, regardless of your receiver settings.

Your stereo VCR, stereo television, or DVD player sends the encoded program material to the surround-sound receiver, which interprets and distributes the information to the Powered Acoustimass module. The module delivers the bass for all channels and sends appropriate sounds to each cube array. The sound mix varies with different program types: dialogue is usually sent to the center speaker, a visual soundstage is created by the left and right front speakers, and you feel in the center of the action because sounds and special effects are directed to the surround (rear) speakers. *At any point in a surround-sound performance, you may hear sound from one, a few, or all of the speakers.*

To select surround-encoded program material, look for any of the terms Surround, Dolby Surround, the double-D symbol \*, other digital formats, or the word “surround” preceding a TV broadcast. Your system is fully compatible with the latest home theater receivers. You can also enjoy a wide variety of stereo programming that is not surround-encoded with your Acoustimass 15 speakers.

## Unpack the carton

- Remove any staples from the opened carton flaps.
- Remove the brown inner carton containing the five cube speaker arrays.
- Gently roll the carton over onto its side and then onto its opening.
- Slowly lift the carton from around the Powered Acoustimass module’s packing cushions.
- Do not detach the removable cables connected to the Powered Acoustimass module.
- If the speakers or the module appear damaged, do not use them. Repack everything in the original carton and contact your authorized Bose dealer immediately.

 **Note:** Now is a good time to record the serial number of these speakers on page 2 of this guide and on your warranty card. Please save all packing materials for possible future use.

 **WARNING:** The Powered Acoustimass module weighs 33 pounds (15 kg). Use good lifting practice to avoid injury.

 **WARNING:** To avoid danger of suffocation, keep the plastic bags that wrap these speakers out of the reach of children.

### Figure 1

What comes in the carton:

- Powered Acoustimass module
- Five cube speaker arrays
- 20' (6 m) system input cable
- Three 20' (6 m) front speaker output cables
- Two 50' (15 m) rear speaker output cables
- 4 large, 4 small rubber feet
- Owner's Guide
- Quick set up guide
- Module power cord

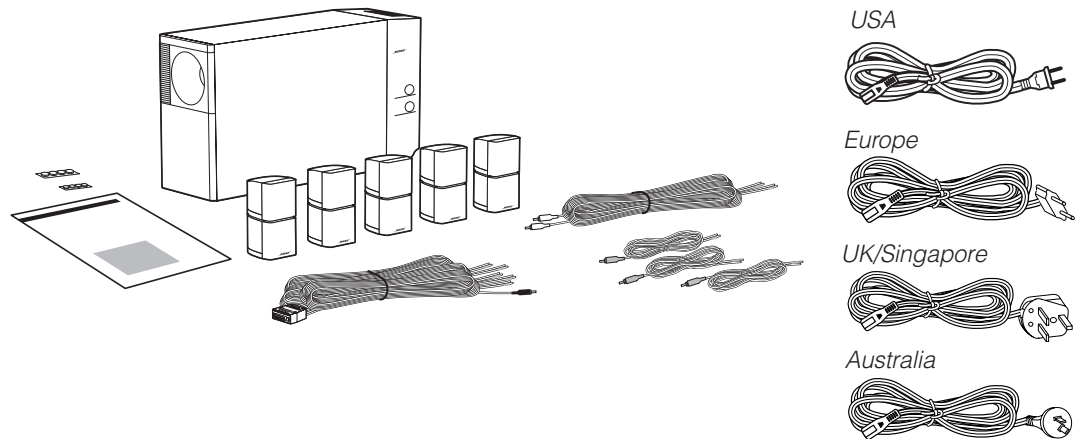

\* Dolby, Dolby Digital, Dolby Pro-Logic, and the double-D symbol are trademarks of Dolby Laboratories Licensing Corporation.

## Placing your speakers to achieve realistic home theater sound

A suggested home theater layout that conforms to the guidelines described above is shown in Figure 2. You may want to place the speakers differently, to take advantage of the sound characteristics of different rooms.

- ♪ **Note:** The cube arrays are identical and can be used for any channel. All of the cube arrays are magnetically shielded to prevent interference with a television picture. Twist the cube arrays so the speakers create room-filling sound patterns.
- ♪ **Note:** Bose wall brackets and floor stands can extend your placement options. See “Accessories” on page 13. Please follow wall bracket instructions carefully. Proper mounting will insure optimum performance from your system.

**Figure 2**

One suggested home theater layout

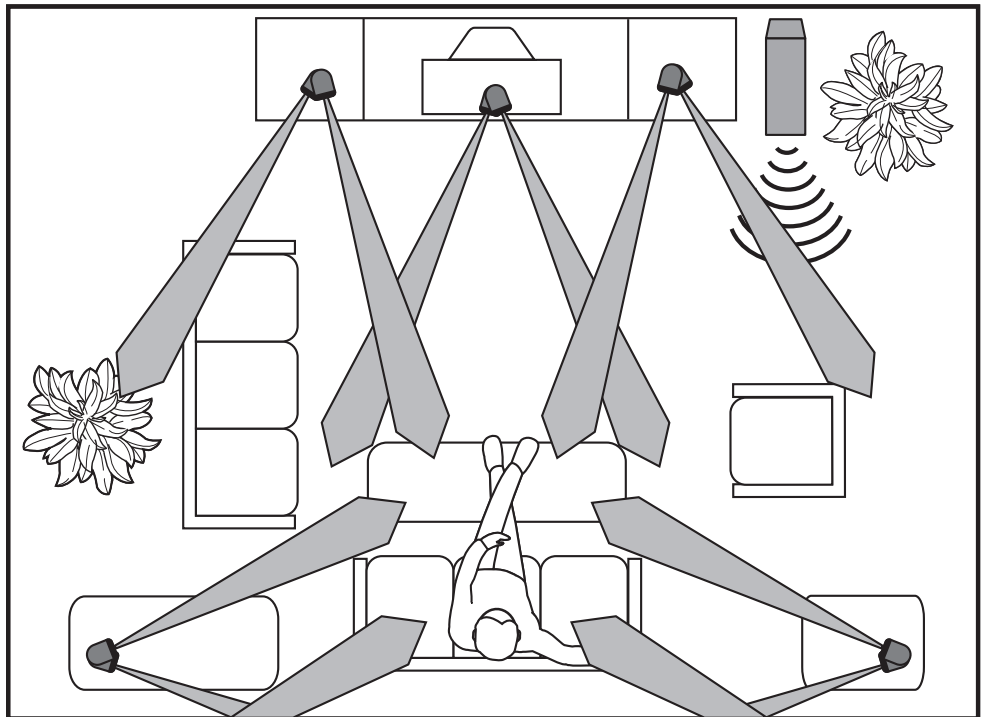

### Center cube speaker

The center speaker localizes action and dialogue on your screen. Sound should seem to come from within the picture.

- Place the center cube array above, below, or on top of your television. If below, be sure that it is not supporting the weight of the television in any way.
- Keep the cube array as close to the vertical center of the screen as possible, for the most accurate dialogue reproduction.

**CAUTION:** If you are placing the center cube array on top of the television, use the smaller of the two sets of four rubber feet provided. This will provide extra stability on surfaces such as marble or glass. Additional rubber feet are available, free, by calling the Bose® customer service numbers inside the back cover of this manual. Ask for Part Number 178321-04.



### Left and right front cube speakers

The left and right front speakers create a sound image wider than the screen that seems natural to viewers sitting anywhere in the room. You can place them near a TV screen with no picture interference. See figure 2.

- Place the front cube arrays on either side of your TV, at least 6 feet (2 m), or as much as 15 feet (5 m) apart.

### Surround cube speakers

The surround, or rear, speakers add discrete sounds and special effects that expand the visual image, bringing the viewer into the center of the action. *The surround speakers may carry dialog as well.* The surround speakers should be positioned to allow the sound to reach the viewer from both sides, rather than from directly behind. See Figure 2.

- Place the speakers at ear height or higher, if possible
- Adjust the rear surround speakers to direct the sound to the front and back of the listener.

### Powered Acoustimass® module

Bose® Acoustimass speaker technology takes advantage of the fact that the source of pure bass sound is difficult to locate, so you can hide the Powered Acoustimass module conveniently out of sight. Place the module at the same end of the room as the television monitor.

- You may hide the module behind or under furniture, but do not block the opening. Be sure there is at least 2 inches (5 cm) between the opening and any surface.
- If the opening faces the wall it increases the bass; if it faces away it decreases the bass. For the most bass response, place the opening 2 to 3 inches (5 to 8 cm) from a wall or corner.
- You may stand the Powered Acoustimass module vertically or horizontally (Figure 3).
- After selecting a place for the module, attach the larger set of four rubber feet to the bottom surface for additional stability.



**CAUTION:** To prevent interference, keep the module at least 2 feet (.6 m) from the television.

**Figure 3**

Powered Acoustimass module positions

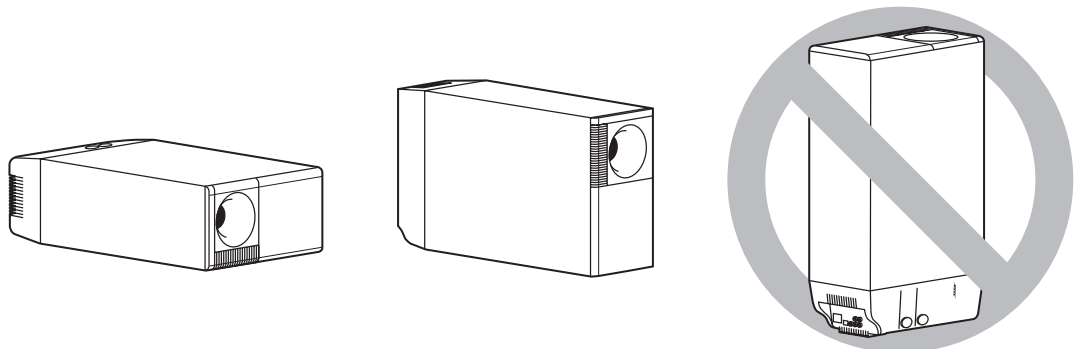



## Connect the speakers

Connect the cube arrays to the Powered Acoustimass® module, and then connect the module to your receiver. The supplied cables make this easy. The cables may be separated or “unzipped” as much as needed to comfortably reach the speakers. See Figure 4.

**Figure 4**

Separating cables

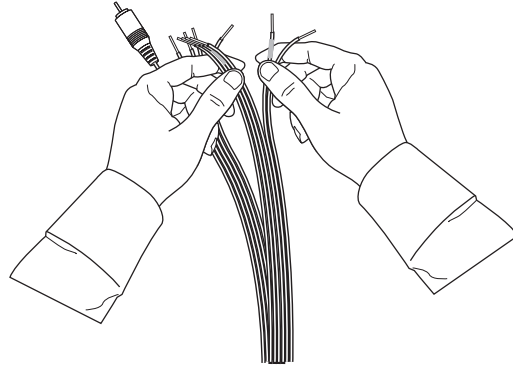

- ⚠ CAUTION:** Before making any connections turn off your receiver and unplug it from the outlet (AC power mains). Not doing so may result in damage to your system.
- ⚠ CAUTION:** Never connect the cubes directly to a receiver output. Always connect the cube arrays to the Powered Acoustimass module, then connect the module to the receiver.
- ⚠ CAUTION:** Never use broken or frayed wiring, which can result in electrical shock or damage to your system. The supplied cables are not intended for in-wall installation. Check local building codes or enlist a qualified installer.

### Connect the Powered Acoustimass module to the center and front cube arrays

Three individual 20 (6m) foot wire pairs connect the Powered Acoustimass module to the **Center, Right, and Left front** cube arrays. Each cable connects to the module with a single plug.

1. Connect the wire pair marked **C** to the center speaker. Just press the terminal tab on the back of the cube array to insert the marked wire into the red terminal and the plain wire into the black terminal. See Figure 5. Release the tab to secure the wires.
2. Connect the wire pair marked **R** to the right front speaker (to the right of the TV as you face it).
3. Connect the wire pair marked **L** to the left front speaker.

**Figure 5**

Making cube speaker connections

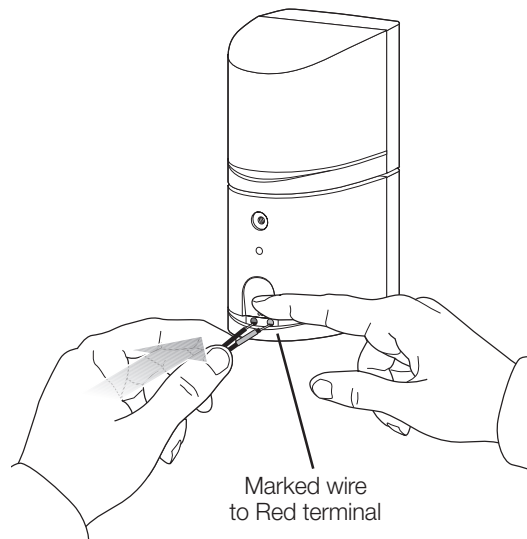

**Connect the Powered Acoustimass® module to the surround cube arrays**

The 50 foot (15 m) cable with *two pairs of wires* connects the Powered Acoustimass module to the **Right and Left surround** cube arrays. Each has an individual plug on the module end.

1. The wire marked **R** connects the module to the right surround speaker (on your right as you face the TV). As shown in Figure 5, press the terminal tab on the back of cube array to insert the marked wire into the red terminal and the plain wire into the black terminal.
2. The wire marked **L** connects the module to the left surround speaker.
3. Insert the connectors firmly into their jacks at the Powered Acoustimass module.

**Connect the Powered Acoustimass module to the receiver**

The 20 foot (6m) cable with *five pairs of wires* and a single wire with an RCA plug connects the module to the **outputs on the receiver** as shown in the table below.

 **Note:** The RCA plug comes with a cover installed. Remove this cover for connection to the LFE/SUBWOOFER OUT jack. If your receiver has no LFE/SUBWOOFER OUT jack, leave the plug cover in place; in this case this wire will not be used.

- Match the polarity on the receiver. Connect the wire pairs in phase (+ to + and – to –).
  - a. Attach each marked wire (+) to the appropriate + terminal.
  - b. Attach each plain wire (–) to the appropriate – terminal.
- Connect the RCA plug to the receiver’s LFE/SUBWOOFER OUT jack.
- At the Powered Acoustimass module, be sure the receiver cable connector is firmly inserted.

WIRE	RECEIVER CONNECTION
CENTER	CENTER (MAIN, A)
RIGHT	RIGHT FRONT (MAIN, A)
LEFT	LEFT FRONT (MAIN, A)
RIGHT SURROUND	RIGHT SURROUND (REAR)
LEFT SURROUND	LEFT SURROUND (REAR)
LFE RCA PLUG	LFE SUBWOOFER OUT

 **CAUTION:** Do not connect the Powered Acoustimass module directly to your television unless the television provides surround decoding circuitry and amplified outputs for all channels.

 **CAUTION:** Do not allow exposed wires to brush against each other; this could damage your receiver.

## Check the connections

Check all connections from the receiver to the Powered Acoustimass module and from the module to the cube arrays (Figure 6). Make sure all cube arrays are connected to the proper terminals according to their position in your room. Check that all wires are connected in phase (+ to + and - to -). Incorrect wiring can result in a total loss of module output. Correct wiring problems before you plug your receiver in and turn it on.

**Figure 6**

Completed connections

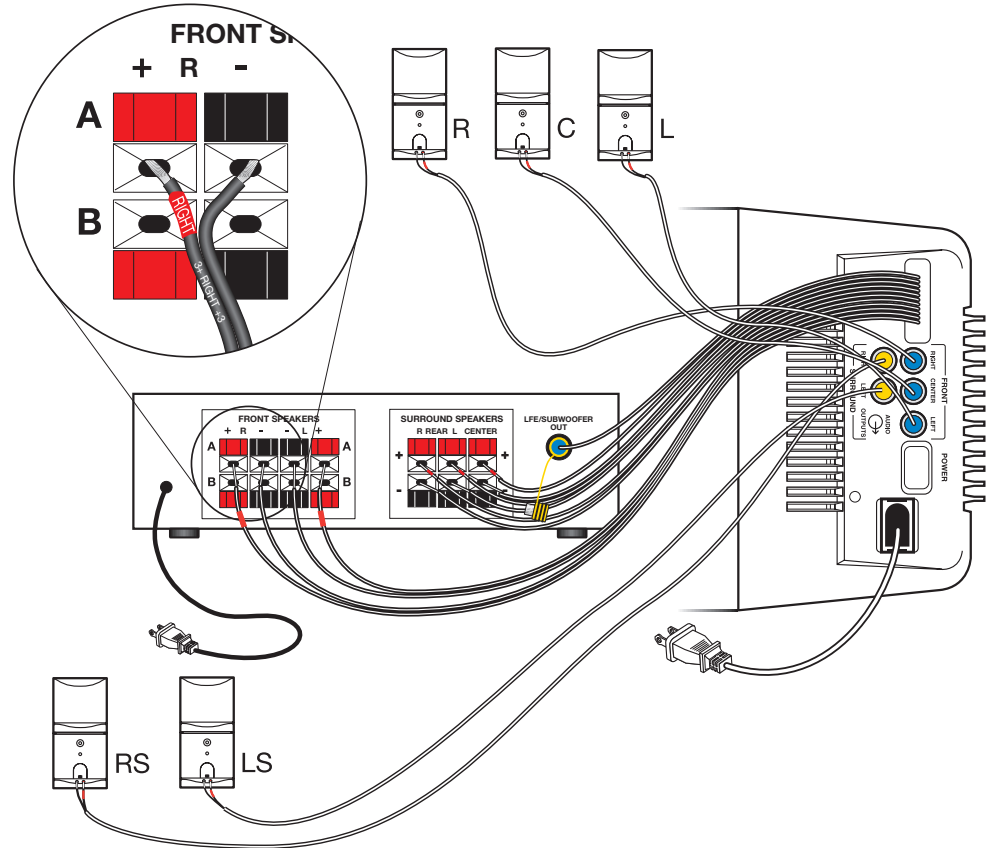

## Plug in the Powered Acoustimass Module

When you have checked all connections, plug in the power cord of the Powered Acoustimass module. Be sure to turn the power switch on (Figure 7). It is not necessary to turn the module off after each use. The speaker system turns on and off automatically as it receives a signal from the receiver. Turn the system off at the receiver.

**Figure 7**

Turn on the Powered Acoustimass module

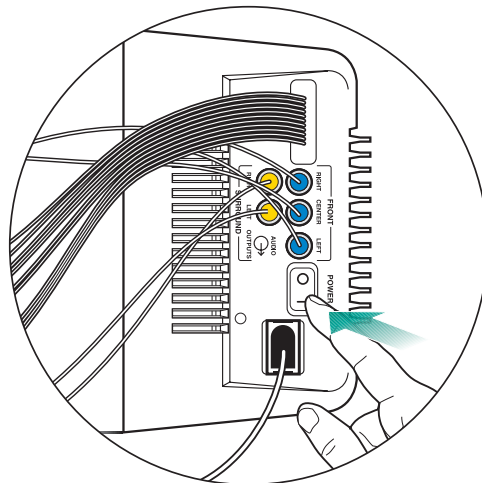

### For realistic home theater sound

#### **LFE level control**

The LFE level control on your Powered Acoustimass module increases or decreases the relative level of low frequency effects on movie soundtracks. Use it to regulate the presence of these underlying deep bass sounds. You may find it unnecessary to adjust this control. The factory, or detent setting is appropriate for a majority of listening situations.

#### **Bass control**

The Bass control on your Powered Acoustimass module can help you customize your listening room. Turning the control to the right will add bass to the sound in rooms that might be characterized as too shrill. Turning down the control will “brighten” the listening room. As with the LFE level control, you may find the factory setting to be completely appropriate for your listening room.

#### **Setting your Dolby Pro-Logic receiver**

For video applications, we recommend the surround-sound *center mode* setting of your receiver as WIDE (Figure 8). Instructions for this process vary, depending on the brand and model of receiver you are using. Follow your receiver owner’s guide for testing and adjusting the balance of each speaker.

**Figure 8**

A Dolby Pro-Logic receiver with the center mode set to WIDE



#### **Setting your Dolby Digital receiver**

Your Acoustimass 15 speakers are fully compatible with the output from Dolby Digital receivers. Integrated Signal Processing assures full bass reproduction for all channels regardless of receiver settings. However, the table below suggests a set of recommended receiver settings. The cube speakers are full-range, or LARGE speakers on the Digital screen menu. Turn the subwoofer and the LFE (low frequency effects) ON. Set the crossover to the lowest number possible, typically 80 Hz.

Speaker	Setting at receiver
Left and Right Front	Large
Center	Large
Left and Right Surround	Large
Subwoofer	ON
LFE (low frequency effects)	ON (at maximum setting)

**Note:** The Acoustimass 15 speaker system incorporates an automatic protection circuit, which guards against most kinds of damage from electrical stress or overload. This circuit activates at high volume levels to reduce output, causing a slight decrease in volume. This is normal operation and indicates that power input may be exceeding safe levels. Sustained listening at these levels is not recommended.

**Be sure to get the Dolby Digital signal**

To be sure that the Dolby Digital or other digital signal from your DVD player reaches your receiver, connect its digital sound output to the digital sound input on your receiver. You must use a coaxial cable, with RCA connectors on each end, or an optical (Toslink) cable that has unique, “square” cable ends. See Figure 9. Be sure to connect the *digital* sound jacks; these are in addition to the traditional analog connections that carry the Dolby Pro-Logic signal. Many DVD players have a switch on the back which you must place in the *digital* position. If you cannot find such a switch, there may be an on screen menu where you must select *digital* audio.

You must also be sure to select Dolby Digital at your receiver’s front panel or remote control. For example, when playing a movie on a DVD, you must select a video output, in this case *DVD*, and an audio output, *Dolby Digital*. You may also have to set up the digital signal using the receiver’s front panel or on-screen menu. Please consult your receiver owner’s manual for specific details.

**Figure 9**

Use either the optical or coaxial digital sound cables and connections for Dolby Digital sound.

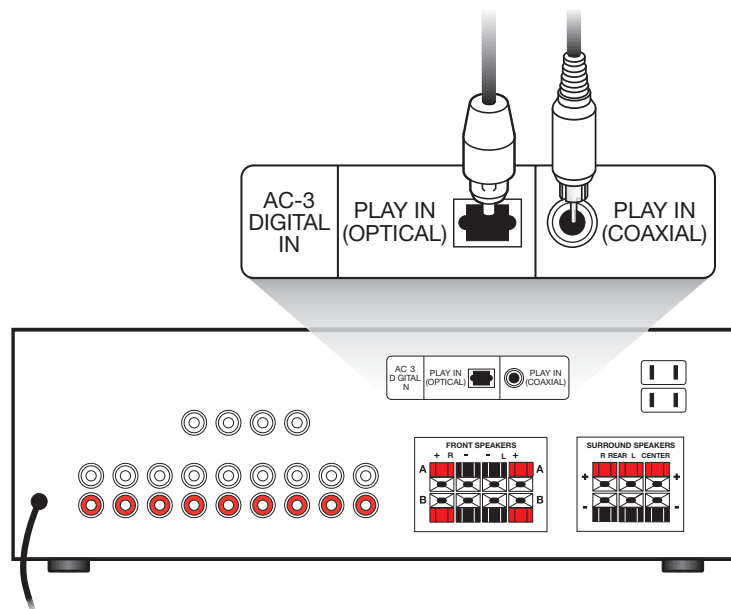

### Troubleshooting

If you have a problem with your Acoustimass 15 speakers, turn off your sound source and try the solutions below. If you still have a problem, contact your Bose® dealer to arrange for service. To contact Bose directly, refer to the inside back cover of this guide.

<b>Problem</b>	<b>What to do</b>
System does not function at all	<ul style="list-style-type: none"> <li>• Make sure the receiver and Powered Acoustimass module are plugged into an operating AC wall outlet and that the units are turned on.</li> <li>• Be sure to select a source at the receiver (video, CD, DVD, tuner).</li> </ul>
No sound	<ul style="list-style-type: none"> <li>• Check the speaker connections.</li> <li>• Turn the Powered Acoustimass module ON.</li> <li>• For digital sound, be sure a coaxial or optical cable connects the digital output of the DVD player with the digital input on your receiver.</li> <li>• Be sure the audio source selected is correct. For example: select DVD audio on your receiver and player for DVD sound.</li> <li>• Disconnect any headphones.</li> <li>• Increase the volume.</li> </ul>
No sound from cube arrays	<ul style="list-style-type: none"> <li>• Be sure the Powered Acoustimass module is plugged in and turned on.</li> </ul>
Sound is distorted	<ul style="list-style-type: none"> <li>• Make sure speaker wire is not damaged.</li> <li>• Reduce the volume of external components connected to the receiver.</li> </ul>
No bass	<ul style="list-style-type: none"> <li>• Make sure the speaker connections at the receiver or amplifier are correct (+ to + and – to –).</li> </ul>
Not enough or too much bass	<ul style="list-style-type: none"> <li>• Move the Powered Acoustimass module closer to a wall or corner to increase bass. Move it farther away from a wall or corner to decrease bass.</li> <li>• Adjust the LFE level control.</li> </ul>
No surround-sound	<ul style="list-style-type: none"> <li>• Be sure your receiver is processing a signal from a Hi-Fi VCR, stereo TV, laserdisc, or DVD player, or other surround-sound source. If you are using the Dolby Pro-Logic mode, check that surround-sound is turned ON. If you are using Digital programming, verify that the settings are correct at the receiver. Be sure the source material (DVD, laser disc, or broadcast programming) is Dolby Digital encoded.</li> </ul>

### Customer service

For additional help in solving problems, contact Bose customer service. See the inside back cover for Bose customer service offices and phone numbers.

### Cleaning the speakers

The cabinets of your Acoustimass 15 speaker system may be cleaned with a soft damp cloth. Do not use any sprays near the system or allow liquids to spill into any openings. Also, do not use any solvents, chemicals, or cleaning solutions containing alcohol, ammonia, or abrasives.

The grille assemblies on the cube arrays may be carefully vacuumed, if necessary. Please note that the drivers are located directly behind the grille cloth, and are easily damaged if reasonable care is not taken.

## Technical information

### Powered Acoustimass® module power rating

USA/Canada: 120V ~ 50/60 Hz 260W

Europe/Australia: 220-240V ~ 50/60 Hz 260W

### Features

- Direct/Reflecting® speaker technology
- Virtually Invisible® speaker design
- Acoustimass speaker technology combined with Integrated Signal Processing
- Magnetically shielded cube speaker arrays
- Automatic system protection circuitry
- Syncom® computer quality control

### Speaker driver complement

Cube speaker arrays: two 2.50-inch (6.35 cm) Twiddler™ speakers

Powered Acoustimass module: two 5.50-inch (14 cm) woofers

### Connectivity

Compatible with A/V receivers and amplifiers rated from 10 to 200 watts per channel, rated from 4 to 8 ohms

### Finish

Cube arrays: Black or Arctic White finish

Powered Acoustimass module: Scratch-resistant Black or Arctic White textured finish

### Size/Weight

Cube speaker arrays: 6.2"H x 3.1"W x 4.0"D (15.7 cm x 7.8 cm x 10.2 cm)

2.4 lb (1.1 kg)

Powered Acoustimass module: 14.0"H x 23.3"W x 7.5"D (35.5 cm x 19.0 cm x 59.0 cm)

33 lb (15 kg)

Packed system: 53 lb (24 kg)

## Warranty period

Bose® Acoustimass 15 speakers are covered by a limited five-year transferable warranty. The built-in amplifier and electronic components are covered by a limited one-year warranty. Details of the warranty are provided on the warranty card that came with your system. Please fill out the information section on the card and mail it to Bose.

## Accessories

Floor stands: UFS-20B (black), UFS-20W (white)

Wall brackets: UB-20B (black), UB-20W (white)

Module input cable adapter for use with existing wiring:

PN194460-001 (black),  PN194460-002 (white)

Module input 20 foot (6.1 m) extension cable: PN198221-001 (black), PN198221-002 (white)



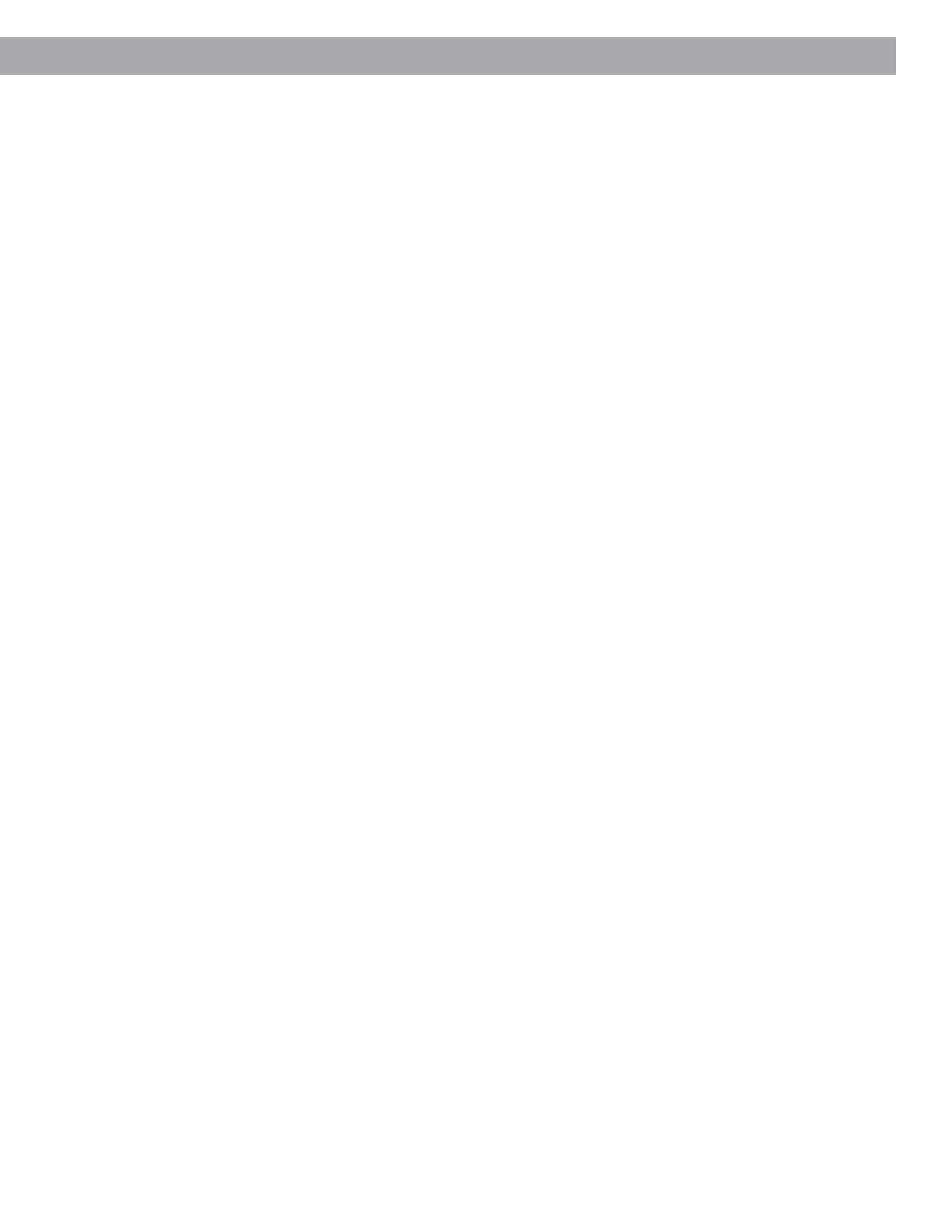

## **USA**

Bose Corporation, The Mountain  
Framingham, MA 01701-9168  
1-800-367-4008  
Phone hours - ET (eastern time):  
Weekdays 8:30 a.m. to 8 p.m.  
Saturdays 9 a.m. to 3 p.m.

## **Canada**

Bose Ltd., 1-35 East Beaver Creek Road  
Richmond Hill, Ontario L4B 1B3  
1-800-465-2673  
Phone hours - ET (eastern time):  
Weekdays 9 a.m. to 5 p.m.

## **European Office**

Bose Products B.V., Nijverheidstraat 8  
1135 GE Edam, Nederland  
TEL 0299-390111 FAX 0299-390114

## **Australia**

Bose Pty Limited, 1 Sorrell Street  
Parramatta, NSW, 2150  
TEL 02 9204-6111 FAX 02 9204-6122

## **Belgique/België**

Bose N.V., Limesweg 2, B-3700 Tongeren  
TEL 012-390800 FAX 012-390840

## **Danmark**

Bose A/S, Industrivej 7, 2605 Brøndby  
TEL 4343-7777 FAX 4343-7818

## **Deutschland**

Bose GmbH, Max-Planck-Straße 36d  
D-61381 Friedrichsdorf  
TEL 06172-71040 FAX 06172-710419

## **France**

Bose S.A., 6, rue Saint Vincent  
78100 Saint Germain en Laye  
TEL 01-30616363 FAX 01-30614105

## **India**

Bose Corporation India Private Limited  
W-16, Greater Kailash-II  
New Delhi 110 048  
TEL (011) 648 4462 FAX (011) 648 4463

## **Ireland**

Bose Corporation  
Carrickmacross, Co Monaghan  
TEL (042) 9661988 FAX (042) 9661998

## **Italia**

Bose S.p.A., Via della Magliana 876  
00148 Roma  
www.bose.it  
TEL 06-65670802 FAX 06-65680167

## **Japan**

Bose K.K., Shibuya YT Building  
28-3 Maruyama-cho  
Shibuya-ku, Tokyo 150  
TEL 3-5489-0955 FAX 3-5489-0592

## **Nederland**

Bose B.V., Nijverheidstraat 8  
1135 GE Edam  
TEL 0299-390111 FAX 0299-390109

## **Norge**

Bose A/S, Solheimsgate 11  
N-2001, Lillestrøm  
TEL 63-817380 FAX 63-810819

## **Österreich**

Bose Ges.m.b.H., Vienna Business Park  
Wienerbergstrasse 7 (10.OG)  
A-1100 Vienna  
TEL 01-60404340 FAX 01-604043423

## **Schweiz**

Bose AG, Rünenbergerstrasse 13  
4460-Gelterkinden  
TEL 061-9815544 FAX 061-9815502

## **Sverige**

Bose A/S, Johannefredsgatan 4  
S-43153 Mölndal  
TEL 31-878850 FAX 31-274891

## **United Kingdom**

Bose Limited  
1 Ambley Green  
Gillingham Business Park  
Gillingham, Kent ME8 ONJ  
TEL 0870-741-4500 FAX 0870-741-4545

## **From other locations**

Bose Customer Service, 1 New York Ave.  
Framingham, MA 01701-9168 USA  
TEL (508) 766-1900 FAX (508) 766-1919

## **World Wide Web**

www.bose.com

***BOSE***<sup>®</sup>  
*Better sound through research*<sup>®</sup>

© 2000 Bose Corporation, The Mountain,  
Framingham, MA 01701-9168 USA  
194452 AM Rev. 06 JN98831